

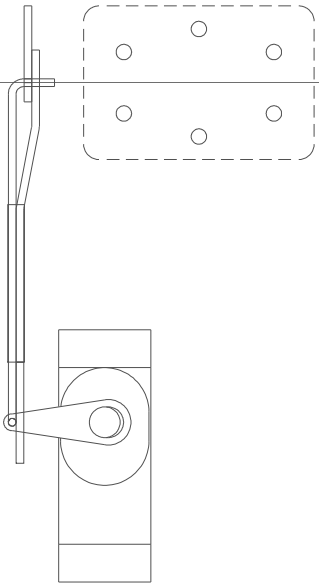

Bring tip to this template

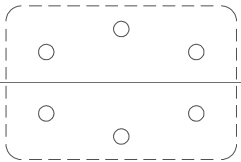

Tape wings

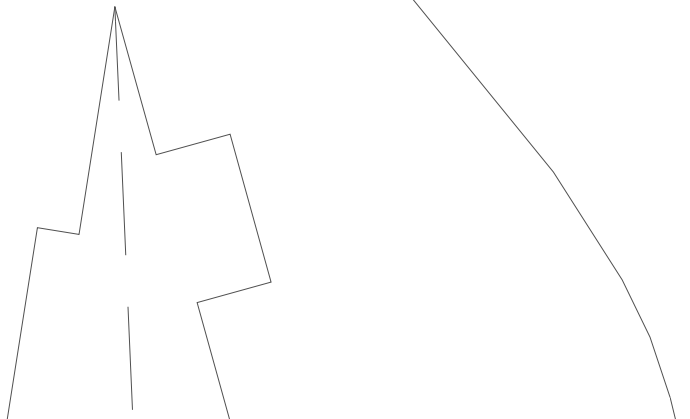

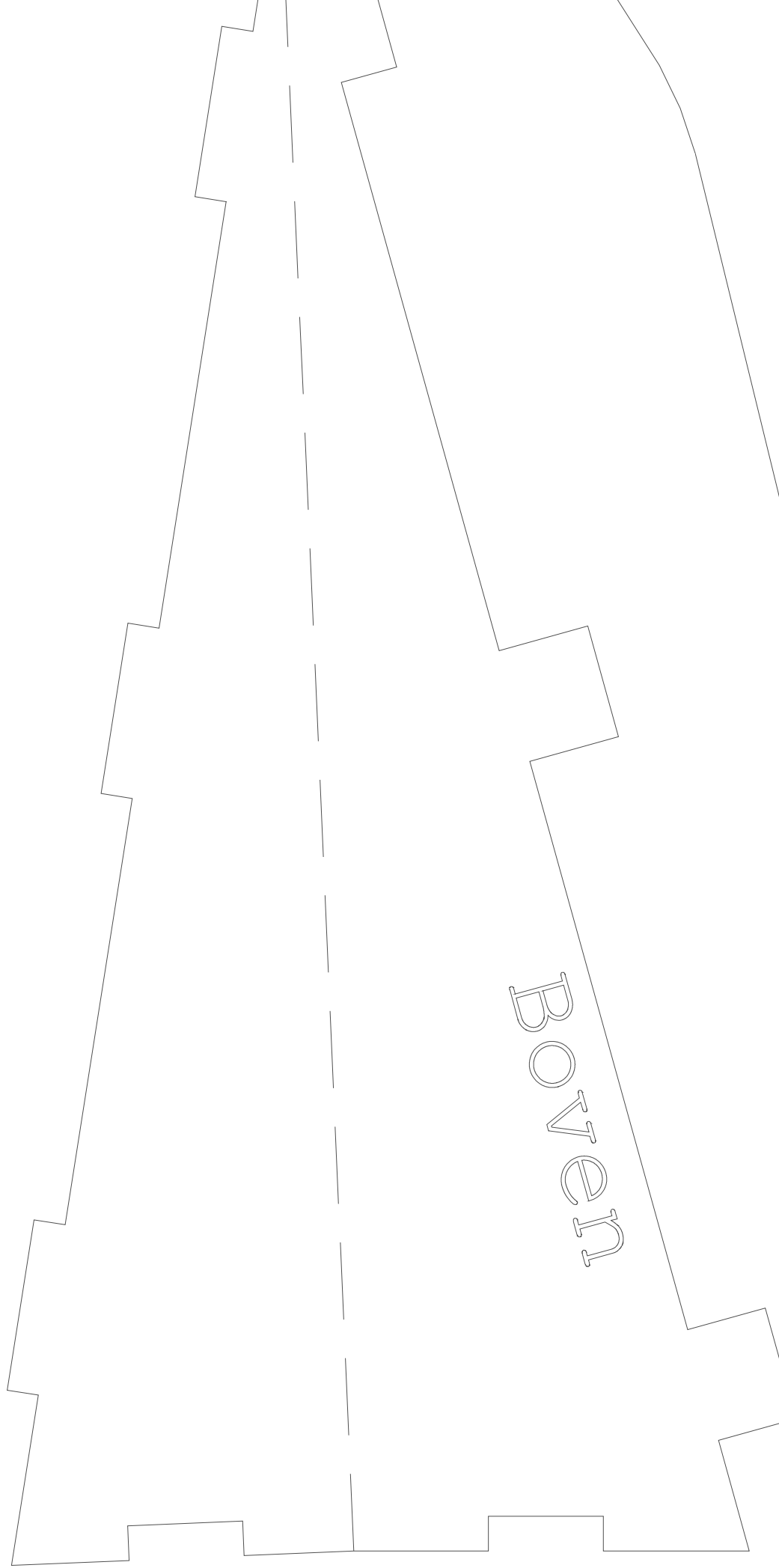

BOYEN

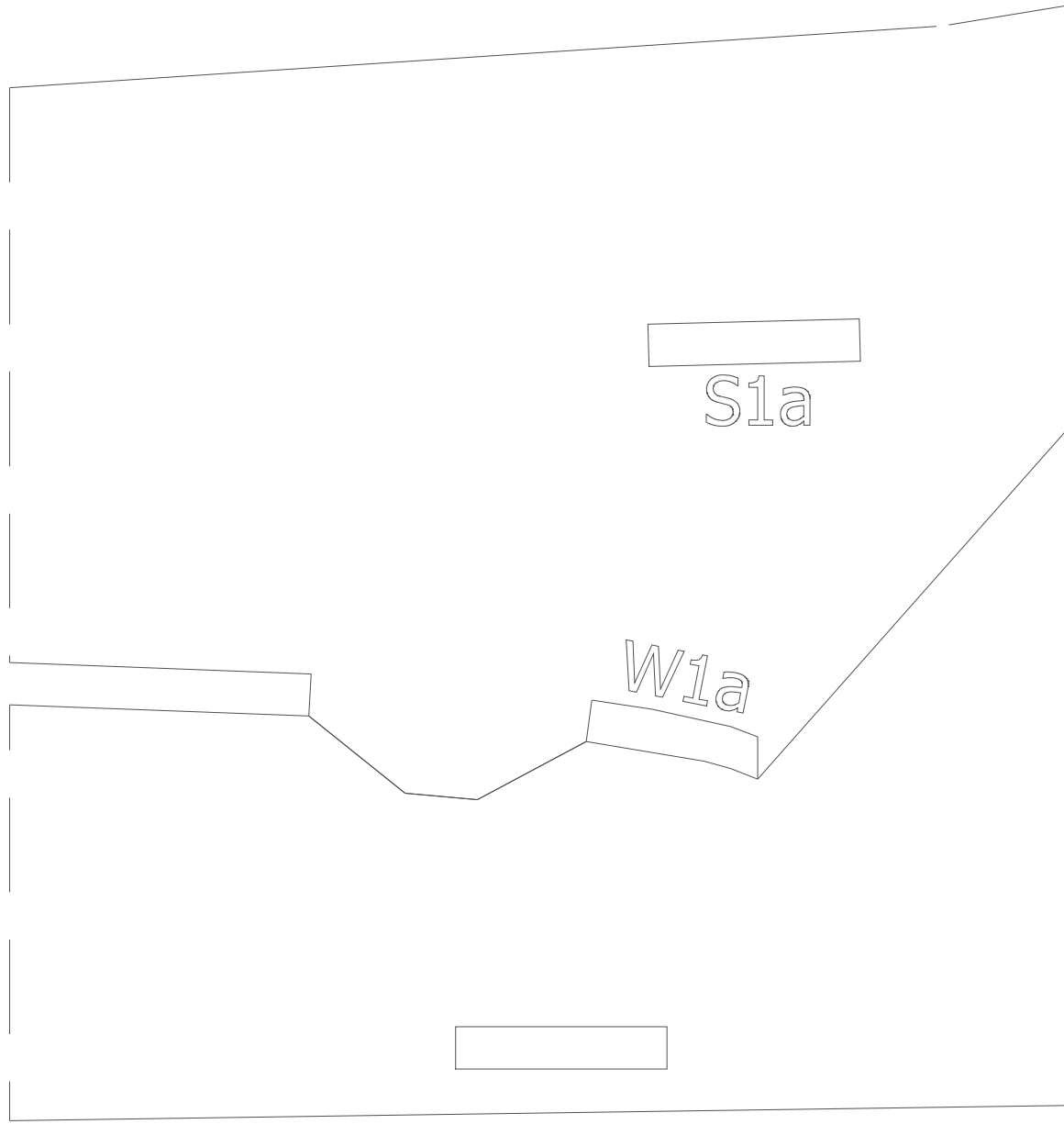

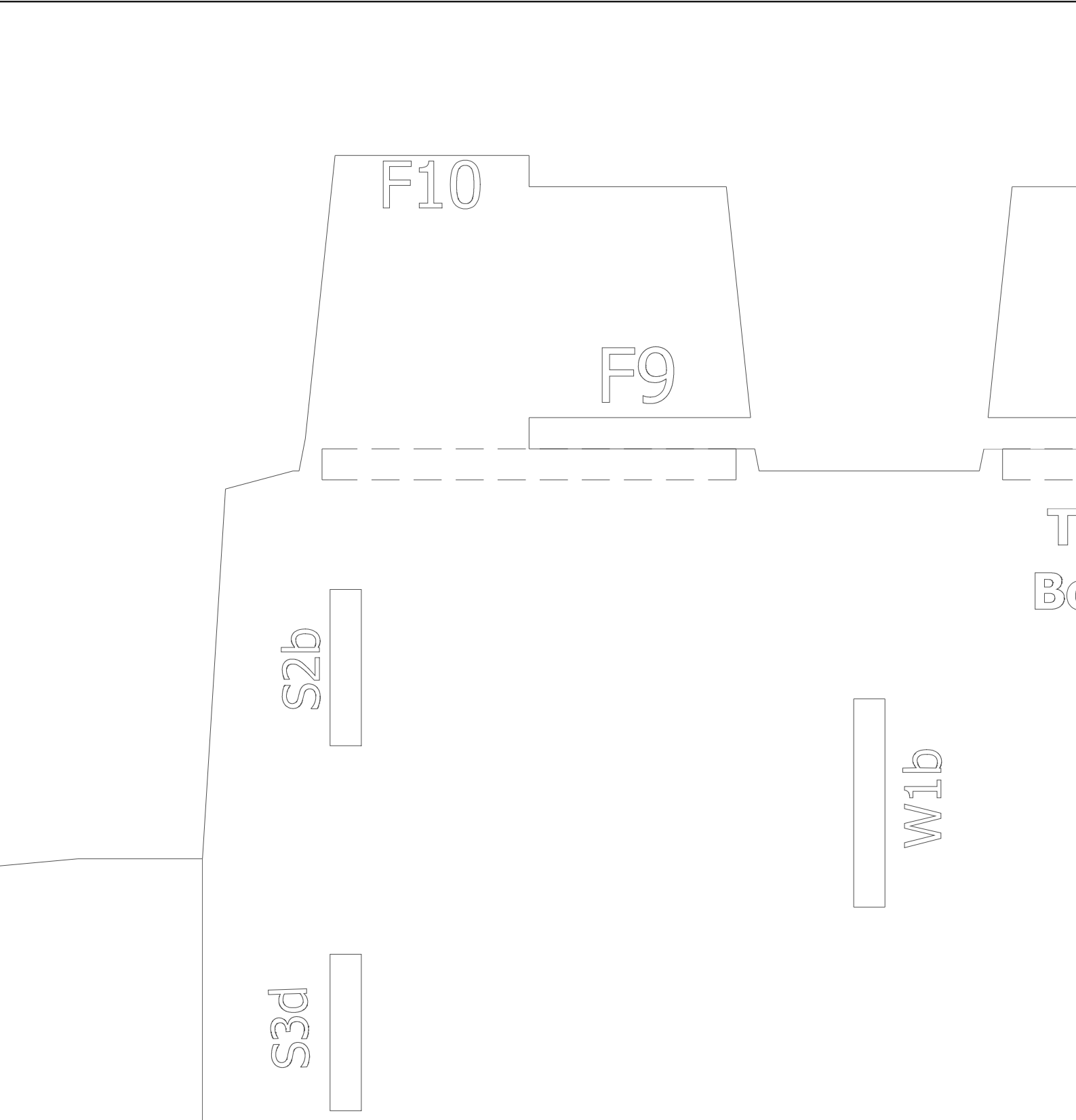



PCS





W1a



S2a

S3c



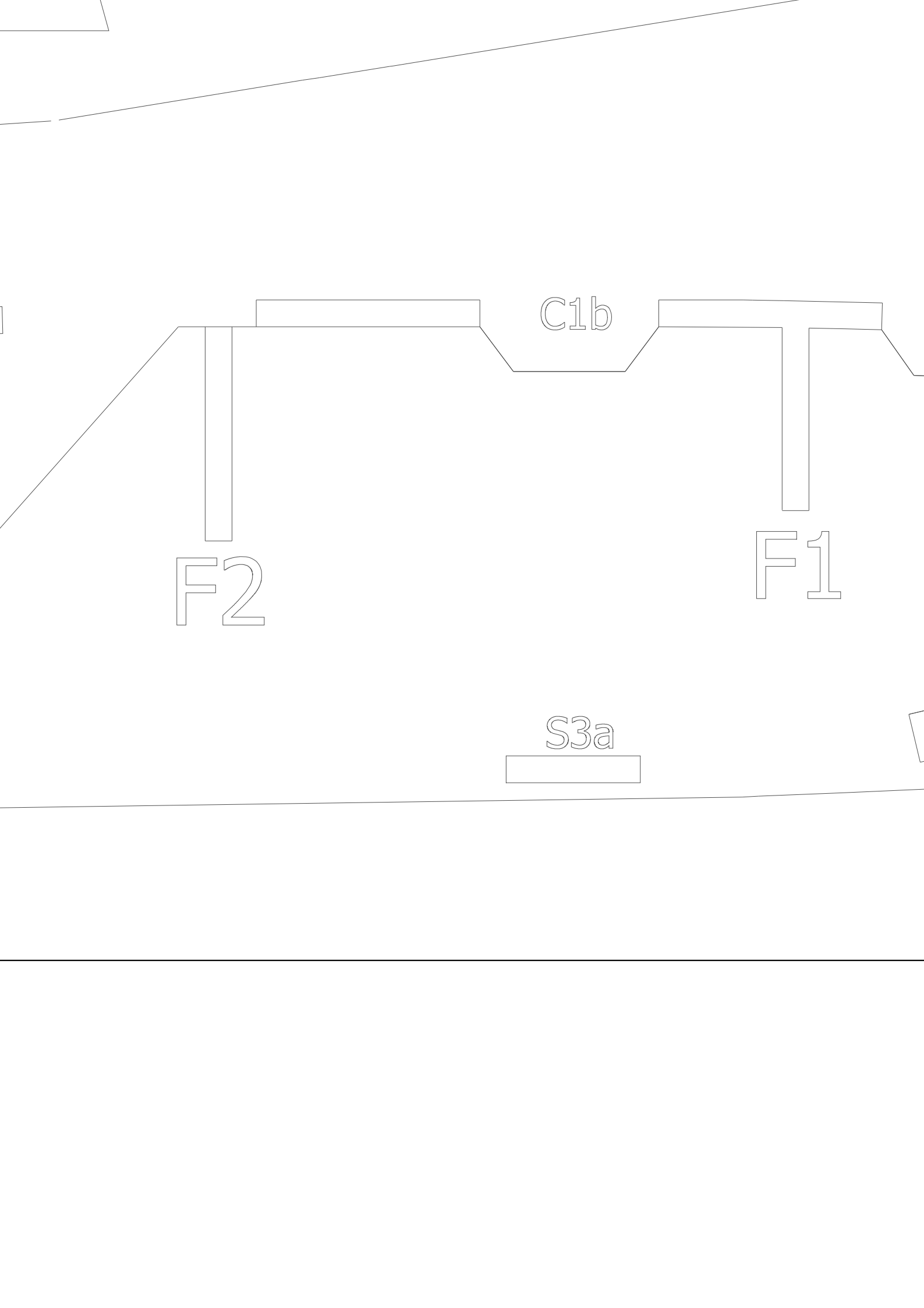

DTM

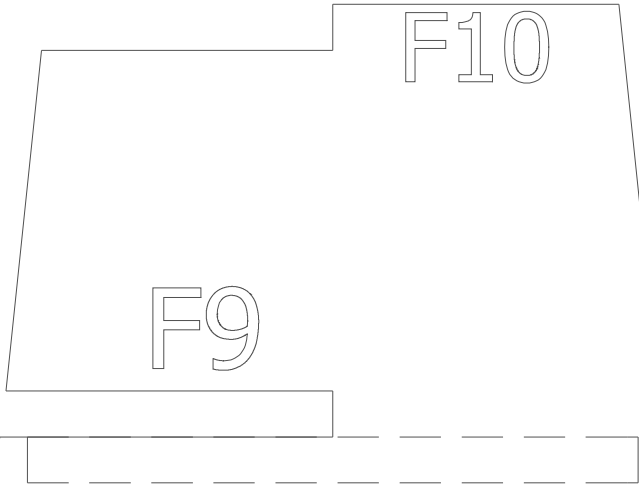

Top: F7
 Bottom: F8



S2b



S3d

Da

By

Wing

Mater

Weig

This

S3d

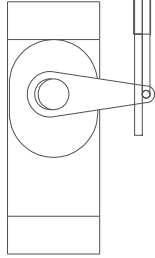
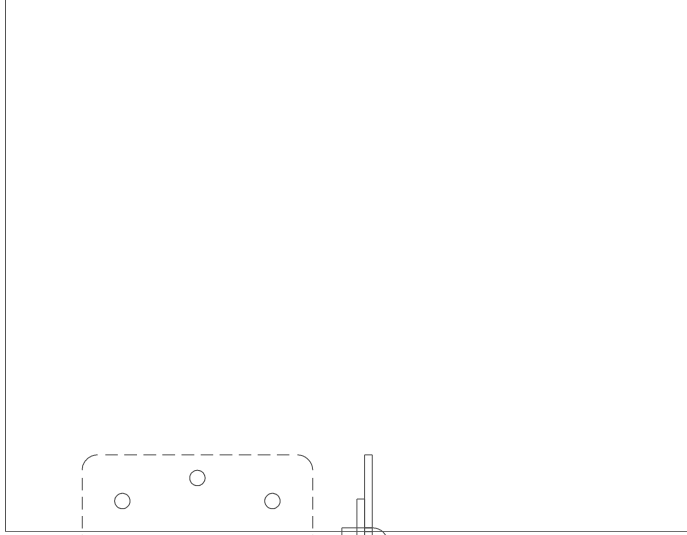

W1

w1



BTMM

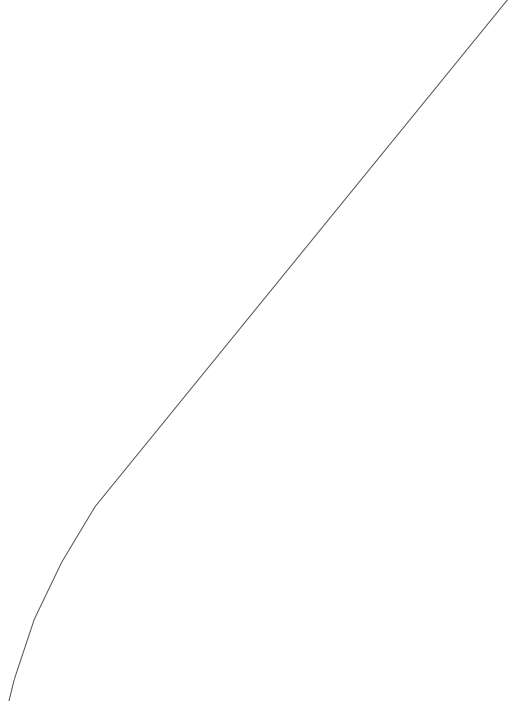

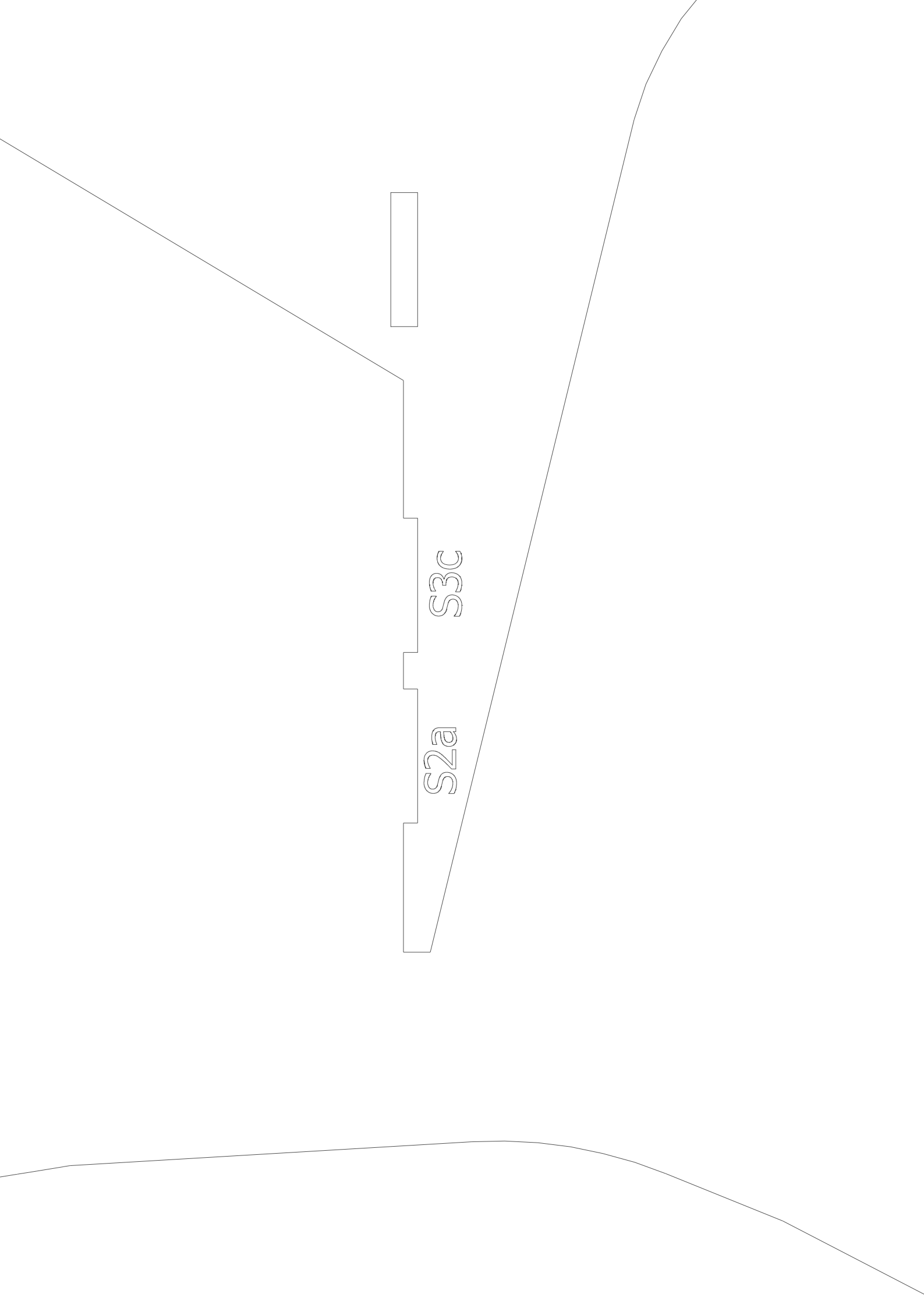

S2a

S3c

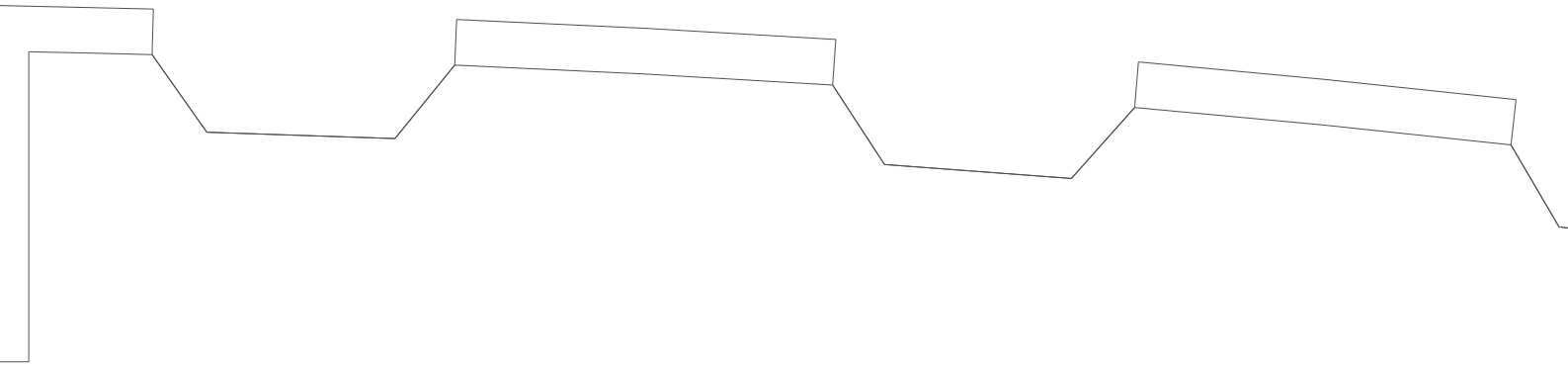

1

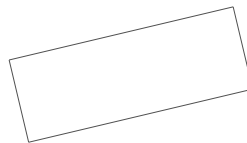
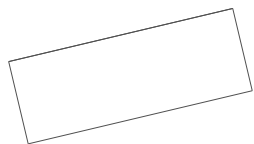

Dassault Aviation R

By: Prop-er

Wingspan: 1000mm (40")

Material: FFF or 6mm Depron

Weight: 300 gr (empty) 600 gr (AUW)

This plan is copyright protected.



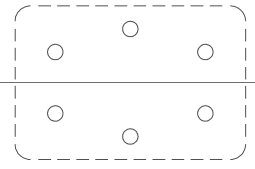
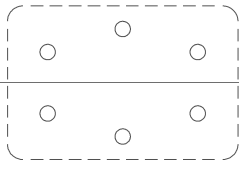

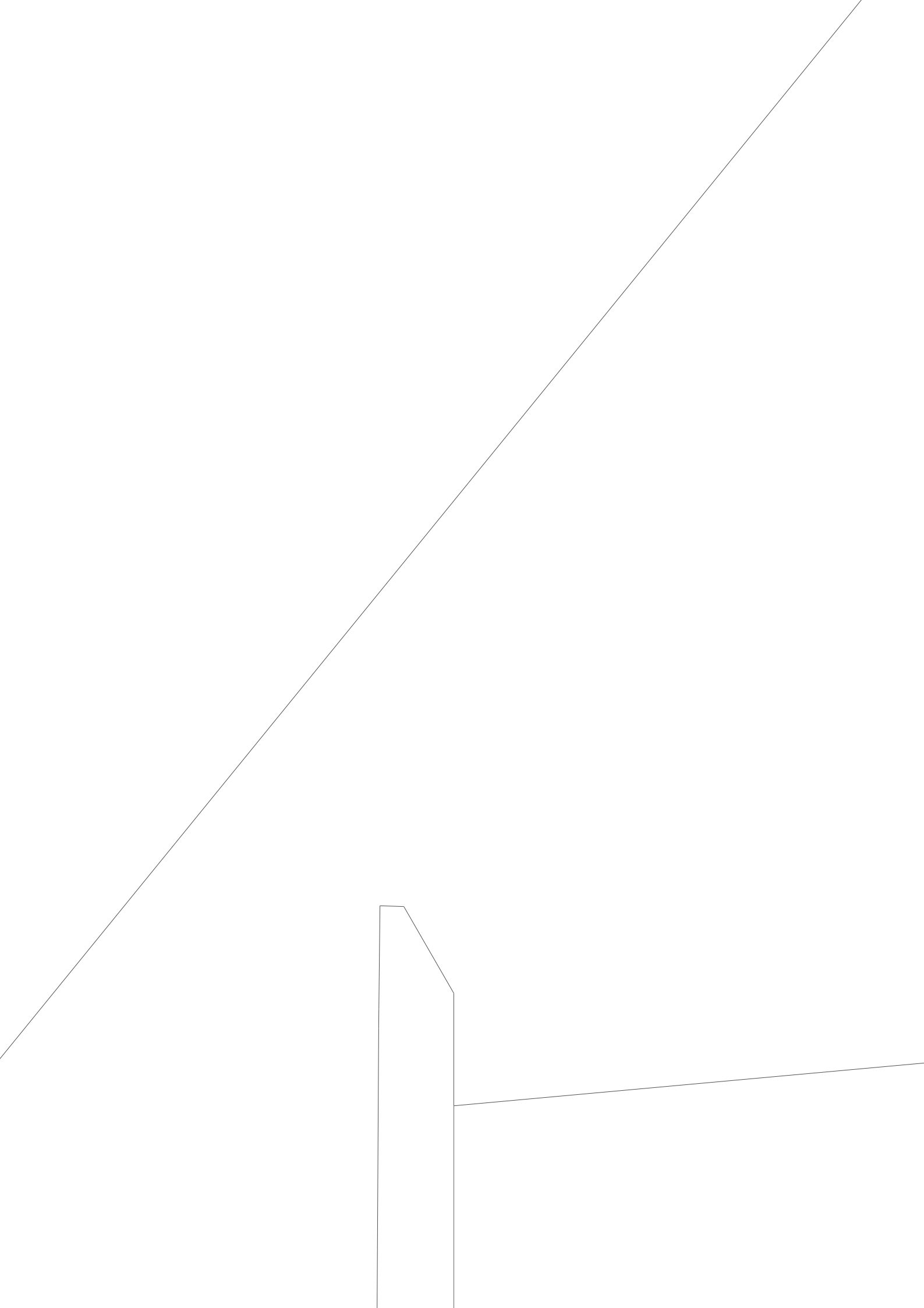

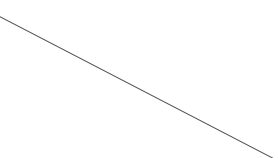
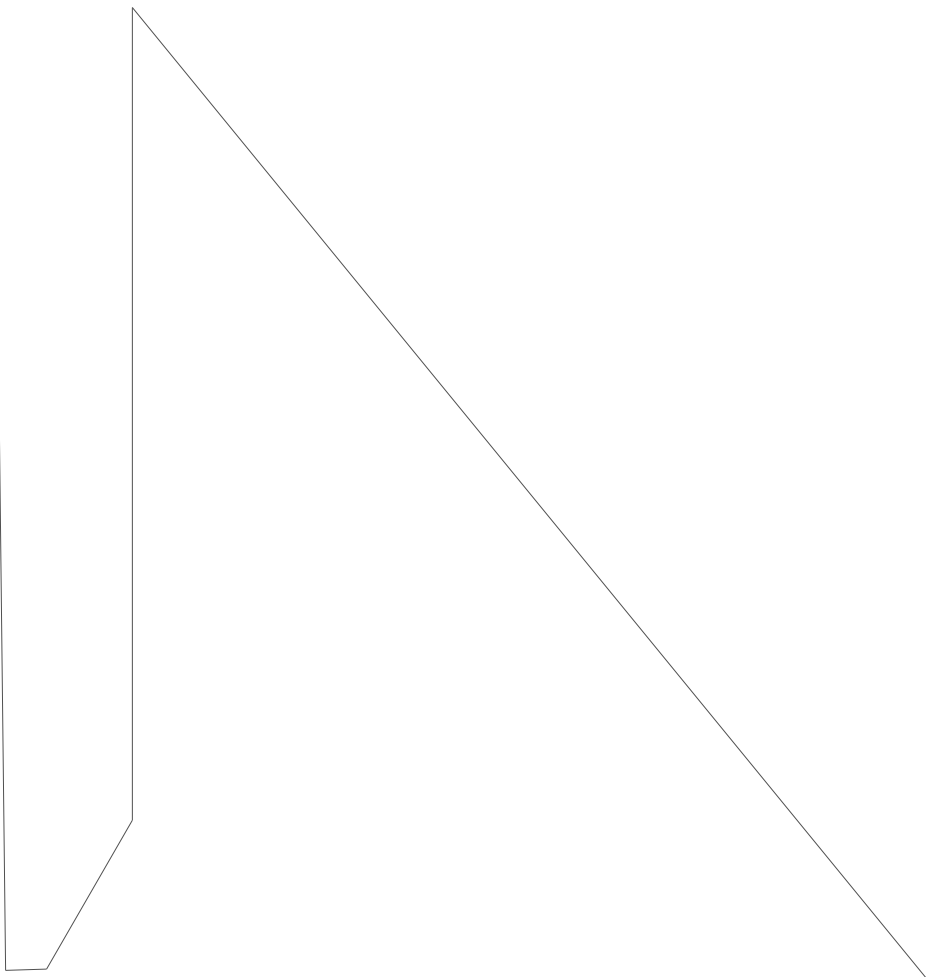
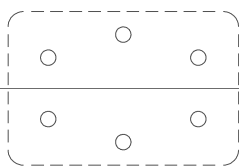

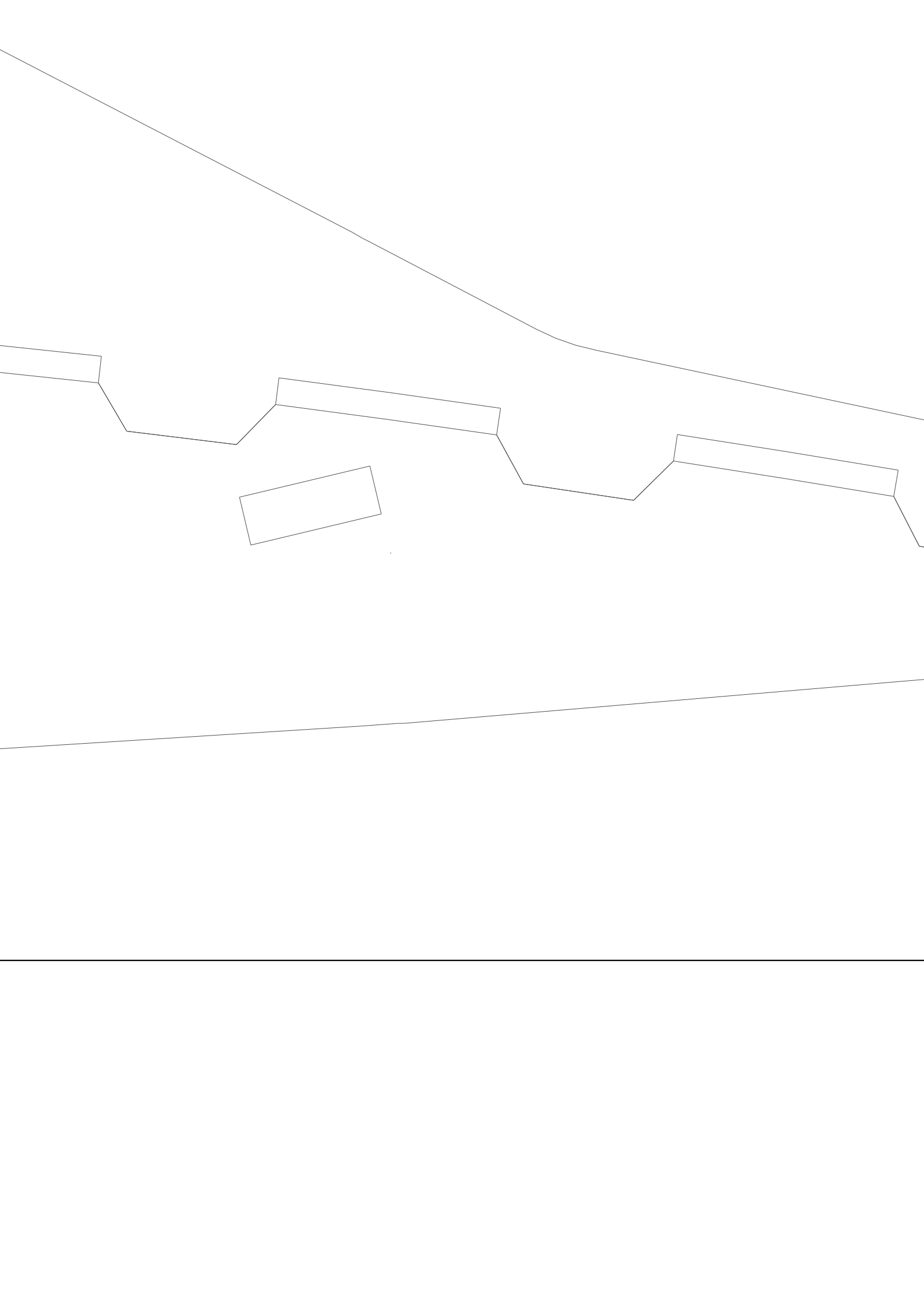

n Rafale XL

Page format: DIN A0 (1189x841mm)

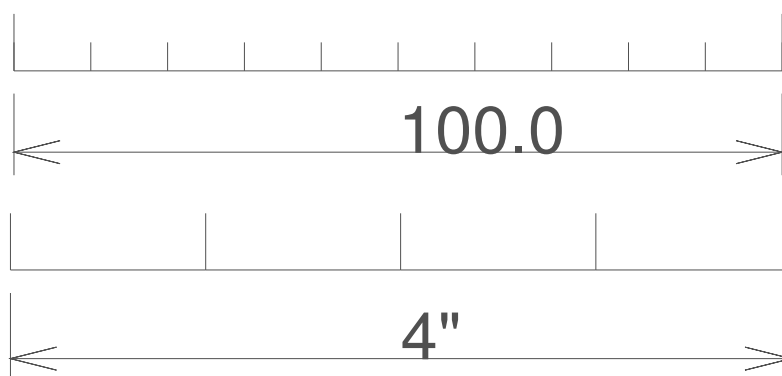

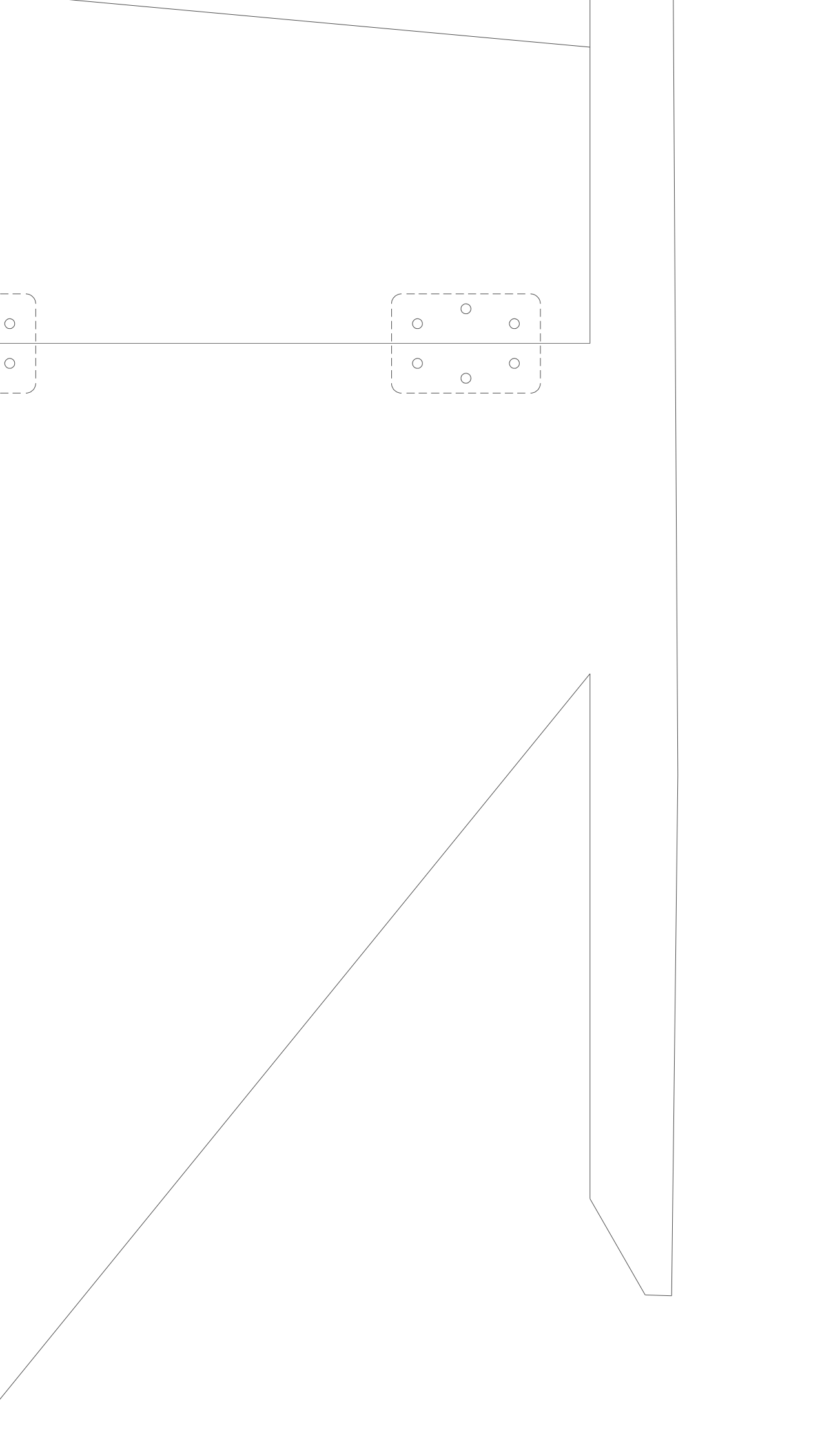



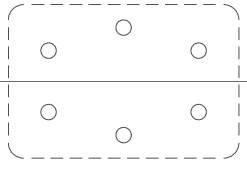
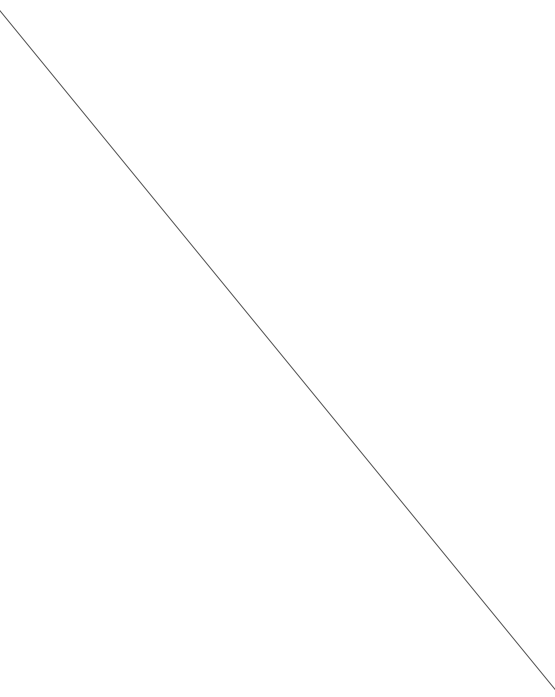

Tape wingtip to wing template



Tapo

C1a

